

SSI - E4

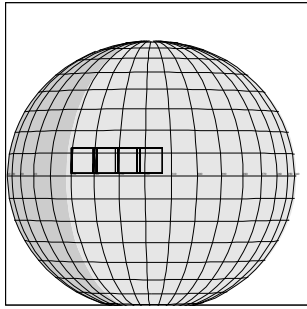

E4JSHOTSP01
JFC-CDS 638:00:0
96-352/16:07:13

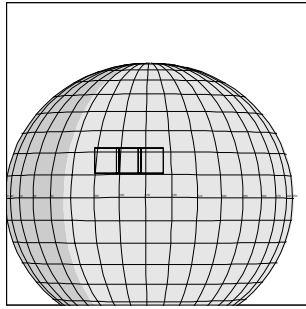

E4JSHOTSP01
JFC-CDS 619:00:0
96-352/16:26:26

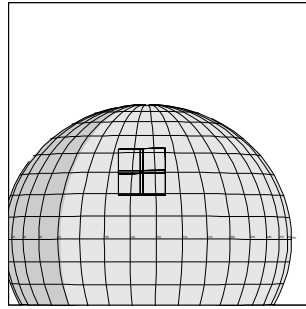

E4JSHOTSP01
JFC-CDS 611:00:0
96-352/16:34:31

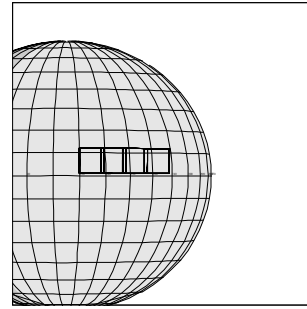

E4JSHOTSP02
JFC-CDS 575:00:0
96-352/17:10:55

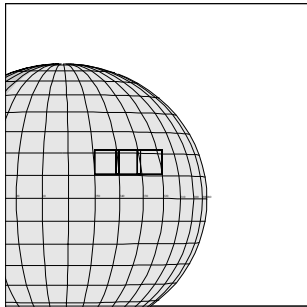

E4JSHOTSP02
JFC-CDS 562:00:0
96-352/17:24:04

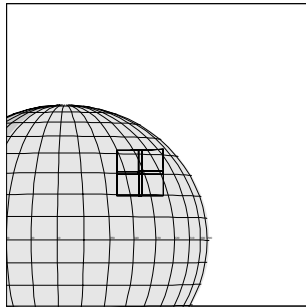

E4JSHOTSP02
JFC-CDS 554:00:0
96-352/17:32:09

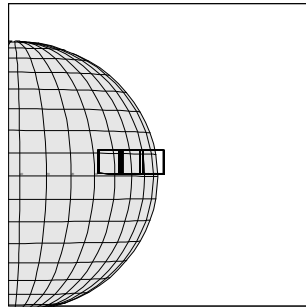

E4JSHOTSP03
JFC-CDS 496:00:0
96-352/18:30:48

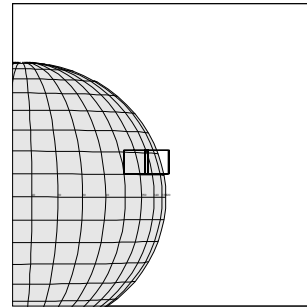

E4JSHOTSP03
JFC-CDS 492:00:0
96-352/18:34:50

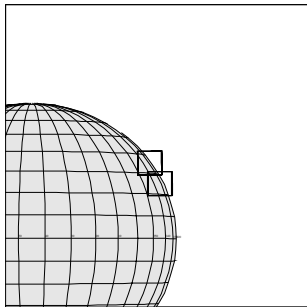

E4JSHOTSP03
JFC-CDS 490:00:0
96-352/18:36:52

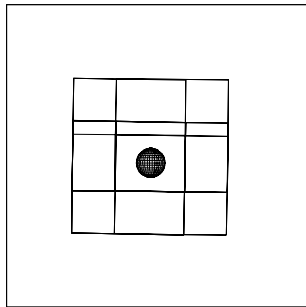

E4ISIOECLI01
IEE-CDS 1535:00:0
96-352/19:44:36

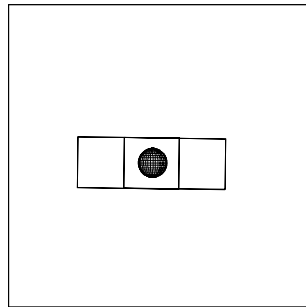

E4ISSURMON01
IEE-CDS 1383:00:0
96-352/22:18:18

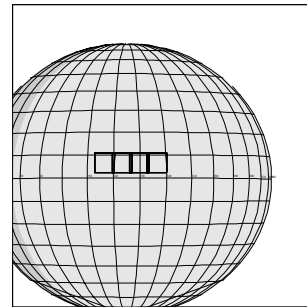

E4JSHOTSP04
JFC+CDS 4:00:0
96-353/02:56:21

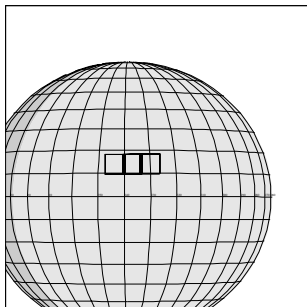

E4JSHOTSP04
JFC+CDS 11:00:0
96-353/03:03:26

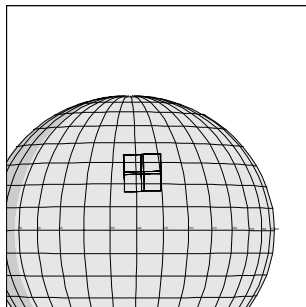

E4JSHOTSP04
JFC+CDS 17:00:0
96-353/03:09:30

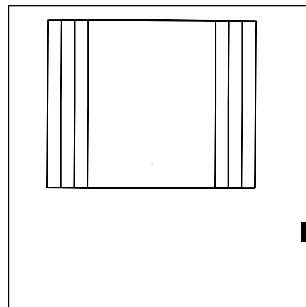

E4ASAMALTH01
EEE-CDS 1410:00:0
96-353/07:09:08

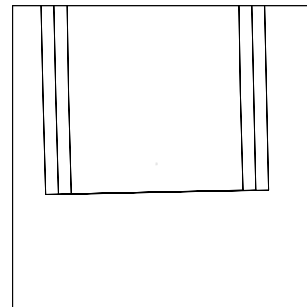

E4SS THEBE01
EEE-CDS 1354:00:0
96-353/08:05:45

SSI - E4

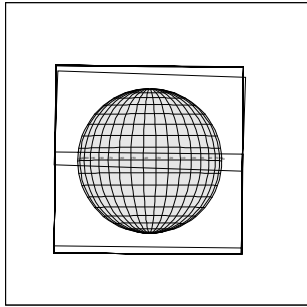

E4ISGLOCOL01
IEE-CDS 557:00:0
96-353/12:13:28

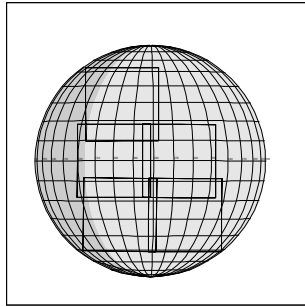

E4ESGLOMAP01
96-354/00:30:34

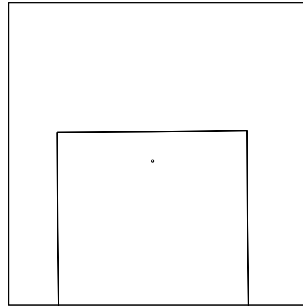

E4SSADRAST01
96-354/03:25:30

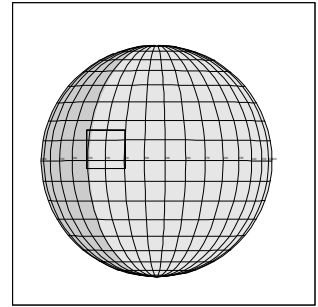

E4ESMACSTR01
96-354/03:35:36

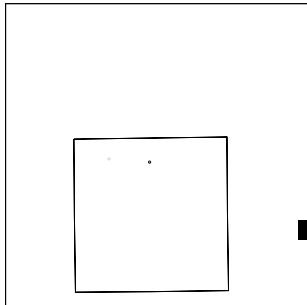

E4SSADRAST02
96-354/04:44:22



E4ESDRKMAT01
96-354/06:12:20

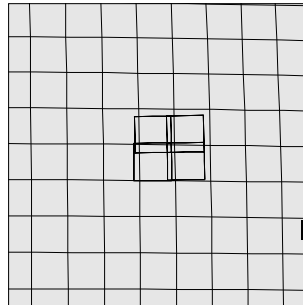

E4ESMACSTR02
96-354/06:38:37

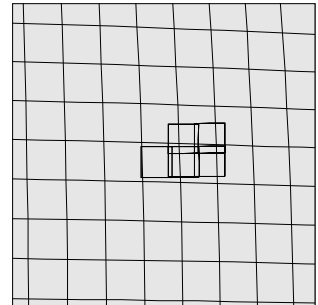

E4ESDRKMAT02
96-354/06:41:39

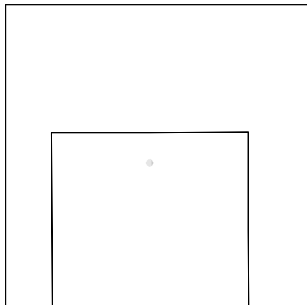

E4ASAMALTH02
96-354/07:20:04

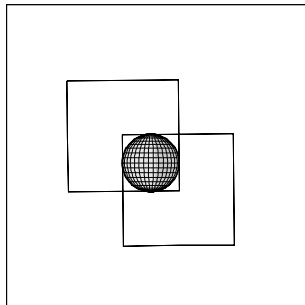

E4ISIOECLI03
96-354/15:30:28

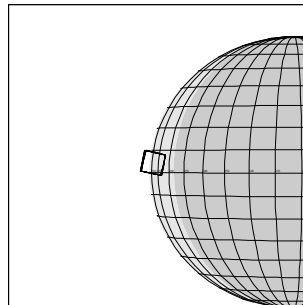

E4JS148PHA03
96-355/06:30:21

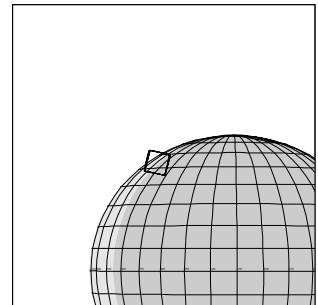

E4JS148PHA04
96-355/06:46:32

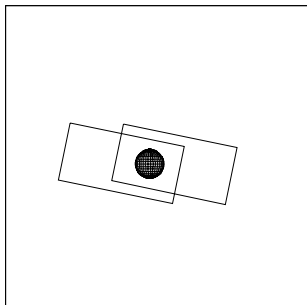

E4ISIONITE01
96-355/10:17:51

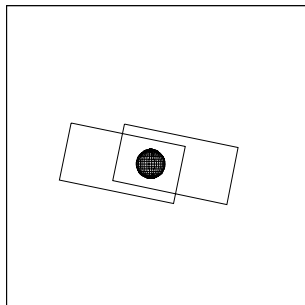

E4ISIONITE02
96-355/10:22:54

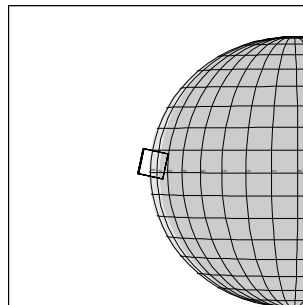

E4JS160PHA03
96-355/16:10:43

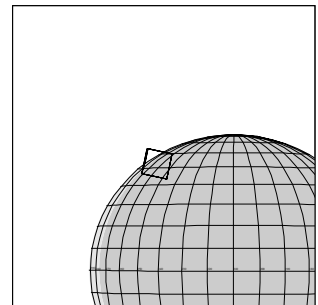

E4JS160PHA04
96-355/16:26:54

