

B-Total, nT

map99\_116A

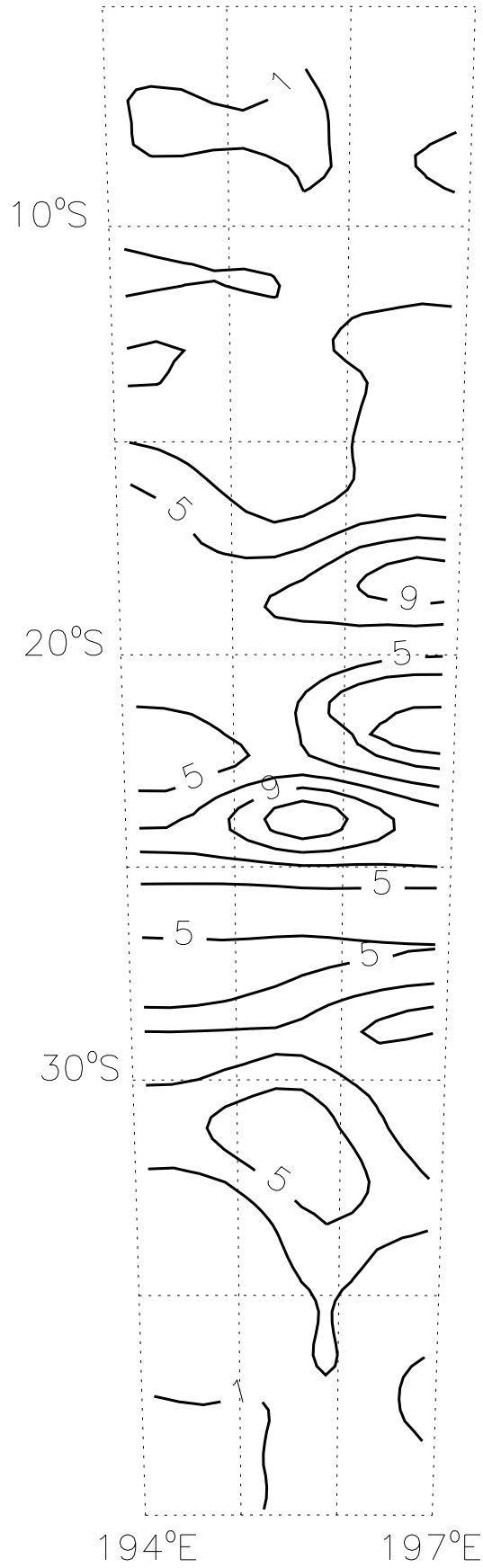

B-Radial, nT      map99\_116A

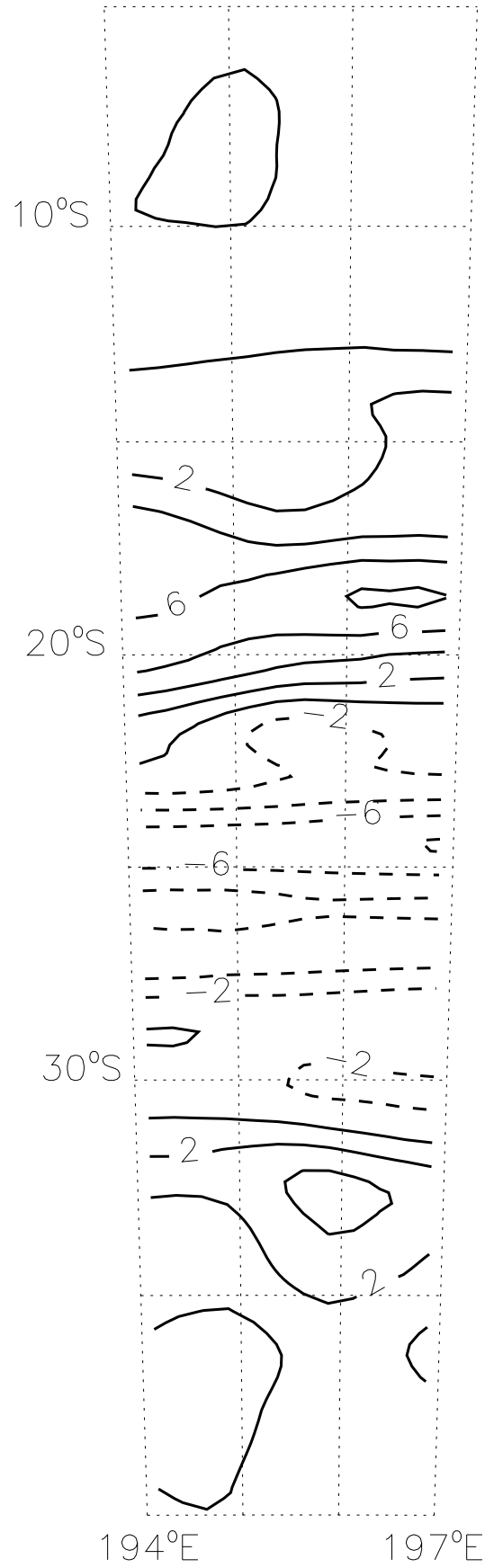

B-East, nT

map99\_116A

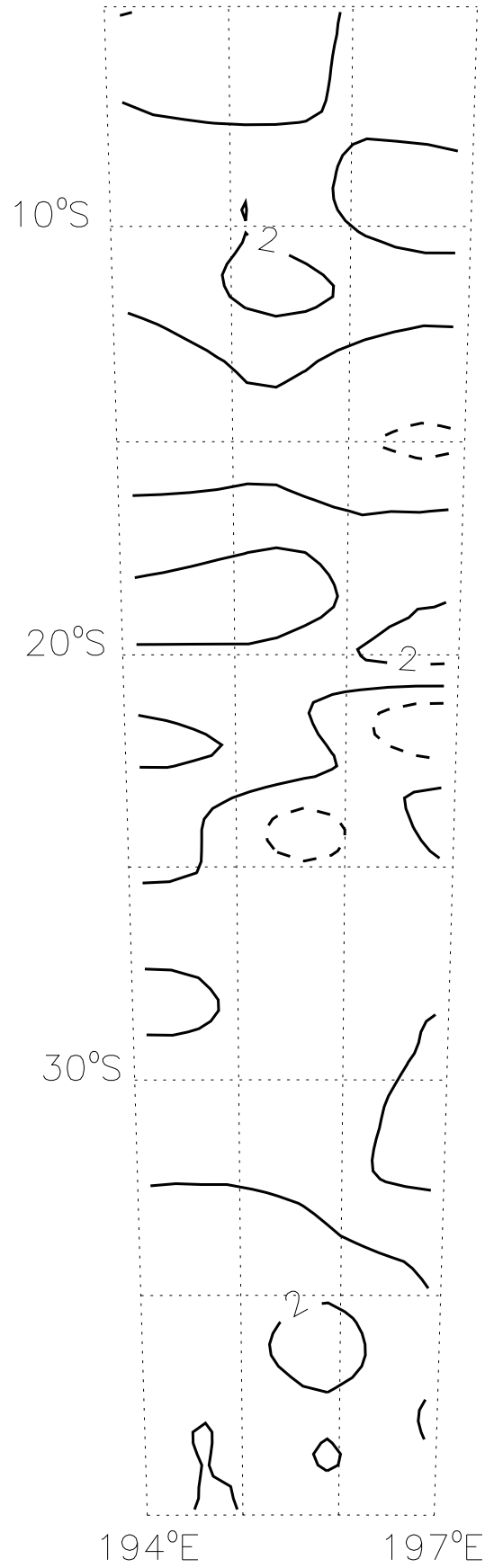

B-North, nT

map99\_116A

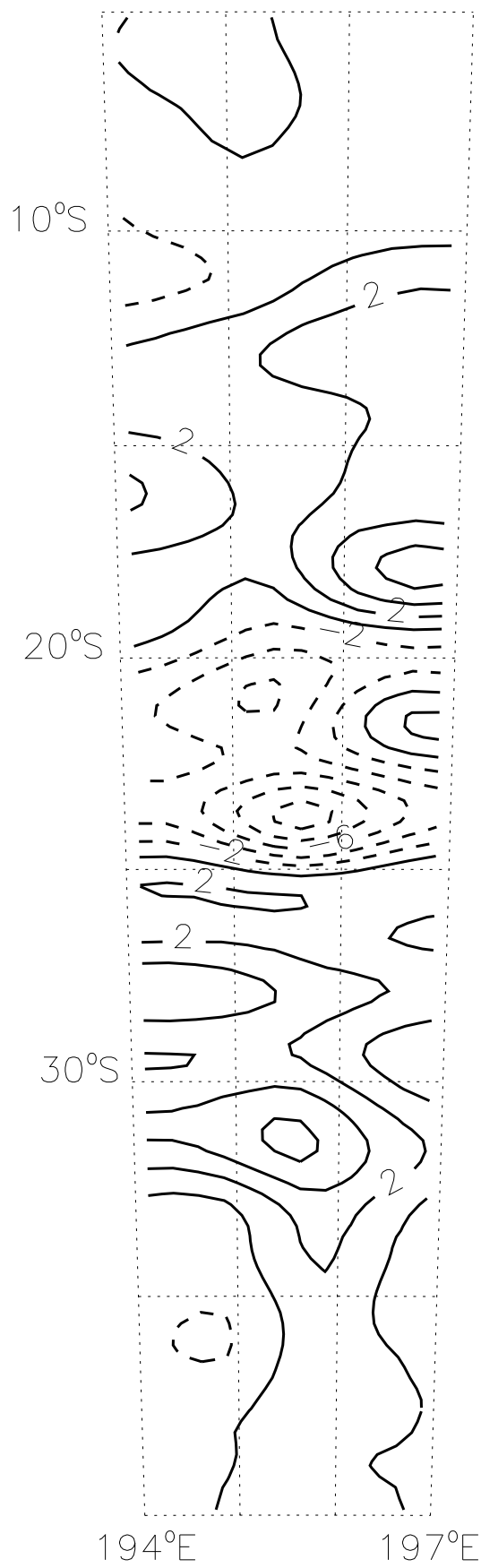

Altitude, km

map99\_116A

