

# SSI - g2

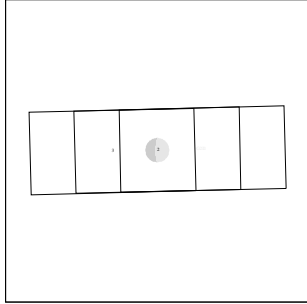

**G2ISPLUMON07**  
IEE-CDS 6064:00:0  
96-246/23:13:38

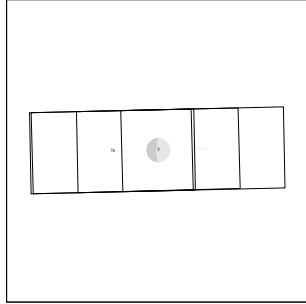

**G2ISPLUMON08**  
IEE-CDS 6000:00:0  
96-247/00:18:21

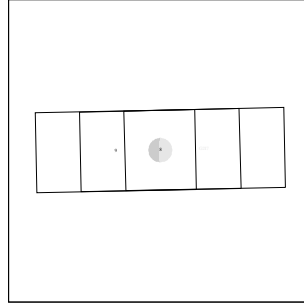

**G2ISPLUMON09**  
IEE-CDS 5936:00:0  
96-247/01:23:03

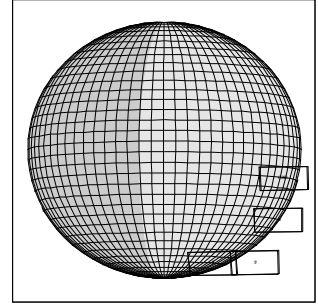

**G2JSSL9LAT01**  
JEE-CDS 5487:00:0  
96-247/17:09:27

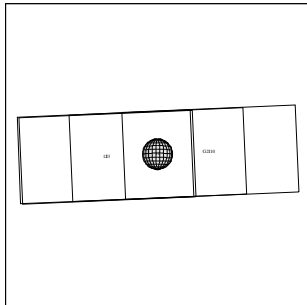

**G2ISPLUMON01**  
IEE-CDS 3846:00:0  
96-248/12:36:17

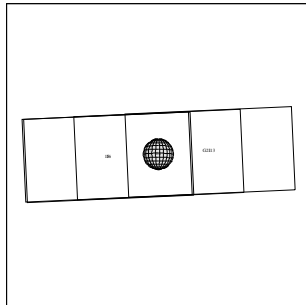

**G2ISPLUMON02**  
IEE-CDS 3771:00:0  
96-248/13:52:07

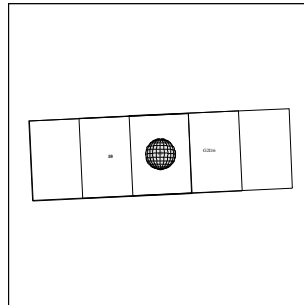

**G2ISPLUMON03**  
IEE-CDS 3698:00:0  
96-248/15:05:55

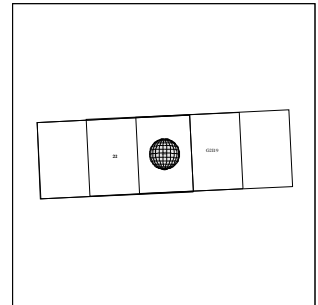

**G2ISPLUMON04**  
IEE-CDS 3628:00:0  
96-248/16:16:42

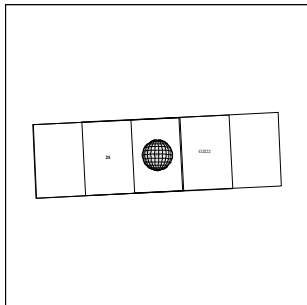

**G2ISPLUMON05**  
IEE-CDS 3558:00:0  
96-248/17:27:29

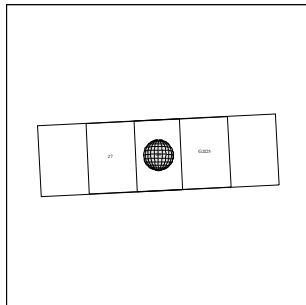

**G2ISPLUMON06**  
IEE-CDS 3492:00:0  
96-248/18:34:13

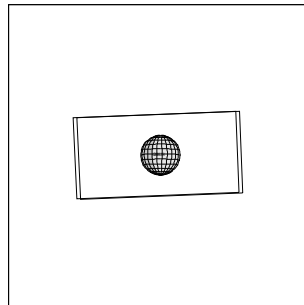

**G2ISPLUMON10**  
IEE-CDS 3176:00:0  
96-248/23:53:43

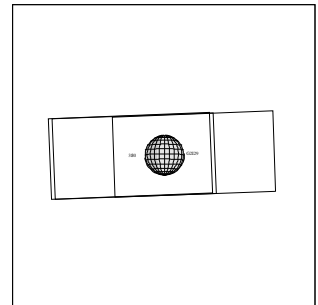

**G2ISPLUMON11**  
IEE-CDS 3115:00:0  
96-249/00:55:24

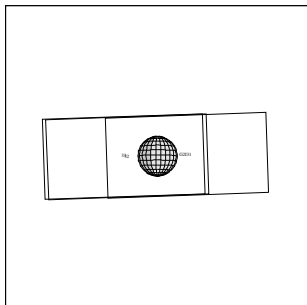

**G2ISPLUMON12**  
IEE-CDS 3050:00:0  
96-249/02:01:07

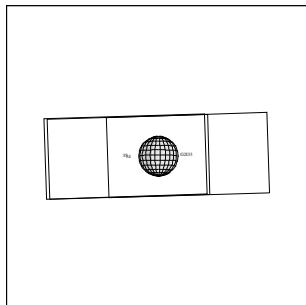

**G2ISPLUMON13**  
IEE-CDS 2990:00:0  
96-249/03:01:47

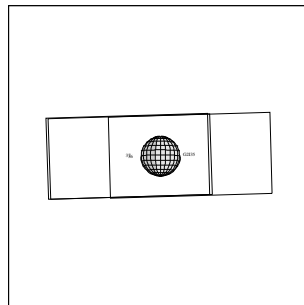

**G2ISPLUMON14**  
IEE-CDS 2923:00:0  
96-249/04:09:32

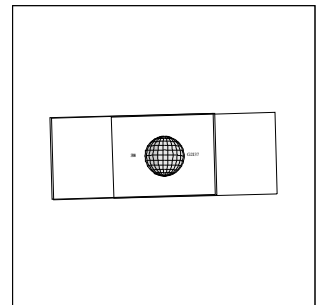

**G2ISPLUMON15**  
IEE-CDS 2862:00:0  
96-249/05:11:13

# SSI - g2

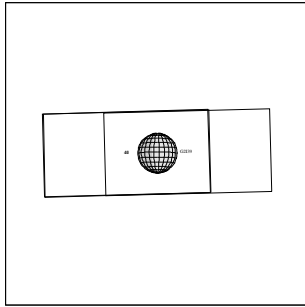

**G2ISPLUMON16**  
IEE-CDS 2793:00:0  
96-249/06:20:59

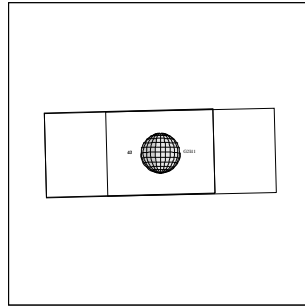

**G2ISPLUMON17**  
IEE-CDS 2723:00:0  
96-249/07:31:45

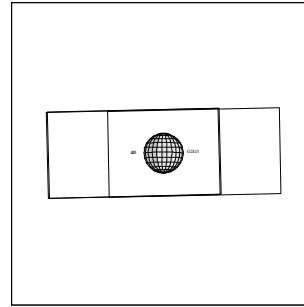

**G2ISPLUMON18**  
IEE-CDS 2651:00:0  
96-249/08:44:33

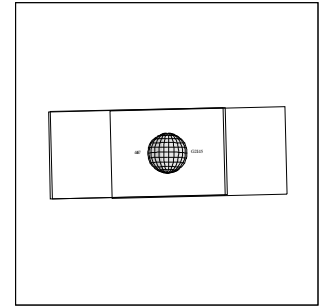

**G2ISPLUMON19**  
IEE-CDS 2585:00:0  
96-249/09:51:17

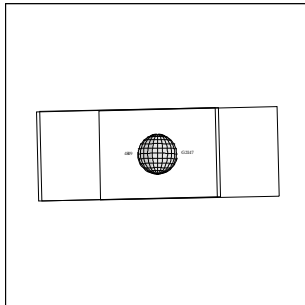

**G2ISPLUMON20**  
IEE-CDS 2496:00:0  
96-249/11:21:17

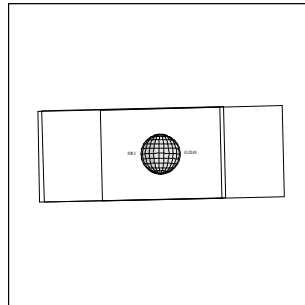

**G2ISPLUMON21**  
IEE-CDS 2422:00:0  
96-249/12:36:06

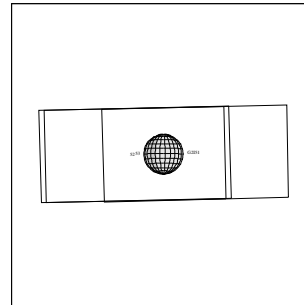

**G2ISPLUMON22**  
IEE-CDS 2339:00:0  
96-249/14:00:01

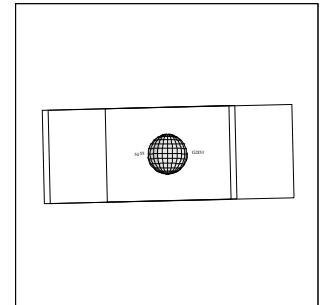

**G2ISPLUMON23**  
IEE-CDS 2253:00:0  
96-249/15:26:59

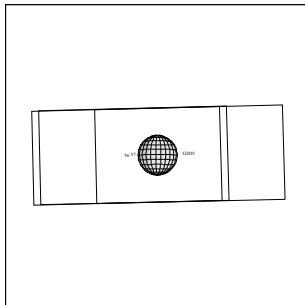

**G2ISPLUMON24**  
IEE-CDS 2163:00:0  
96-249/16:57:59

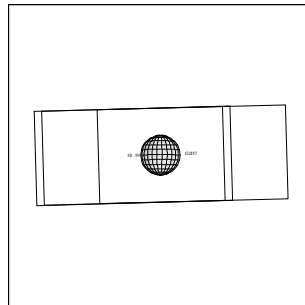

**G2ISPLUMON25**  
IEE-CDS 2072:00:0  
96-249/18:29:59

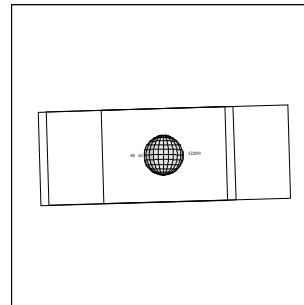

**G2ISPLUMON26**  
IEE-CDS 1977:00:0  
96-249/20:06:03

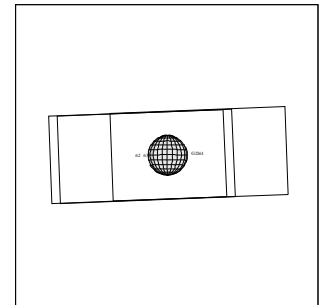

**G2ISPLUMON27**  
IEE-CDS 1680:00:0  
96-250/01:06:21

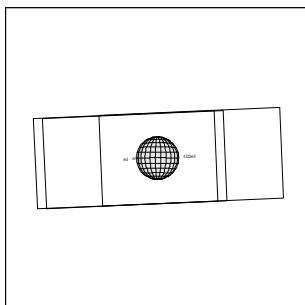

**G2ISPLUMON28**  
IEE-CDS 1578:00:0  
96-250/02:49:29

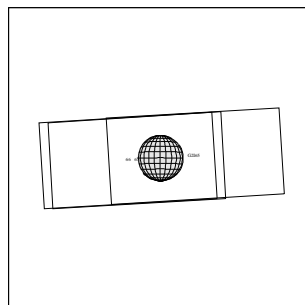

**G2ISPLUMON29**  
IEE-CDS 1369:00:0  
96-250/06:20:48

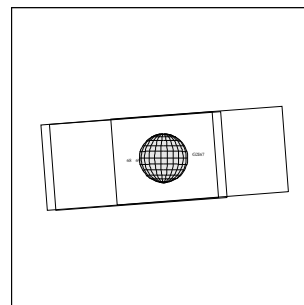

**G2ISPLUMON30**  
IEE-CDS 1264:00:0  
96-250/08:06:58

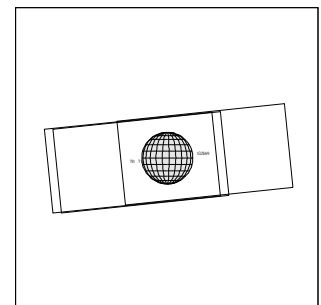

**G2ISPLUMON31**  
IEE-CDS 1162:00:0  
96-250/09:50:06

# SSI - g2

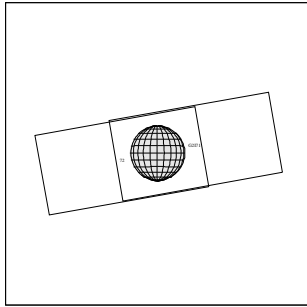

**G2ISPLUMON32**  
IEE-CDS 1056:00:0  
96-250/11:37:17

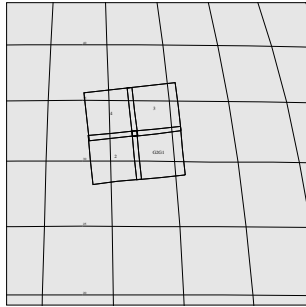

**G2GSTRANST01**  
GTE-CDS 48:00:0  
96-250/18:11:37

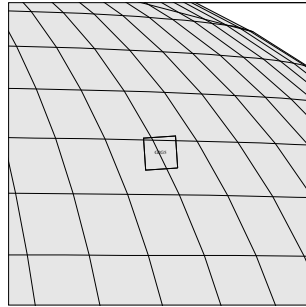

**G2GSGLLREG01**  
GTE-CDS 30:12:0  
96-250/18:29:41

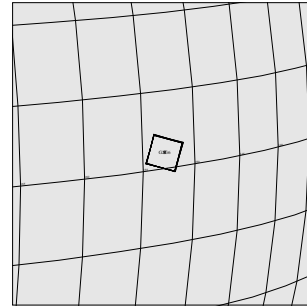

**G2GSCRATER01**  
GTE-CDS 28:26:0  
96-250/18:31:33

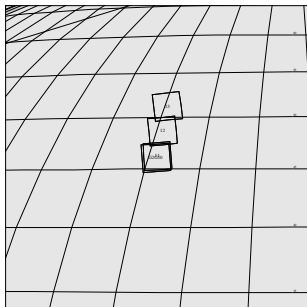

**G2GSNIPPUR01**  
GTE-CDS 25:40:0  
96-250/18:34:26

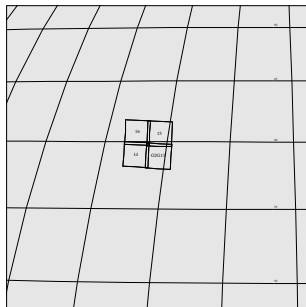

**G2GSGRVLNS01**  
GTE-CDS 24:39:0  
96-250/18:35:27

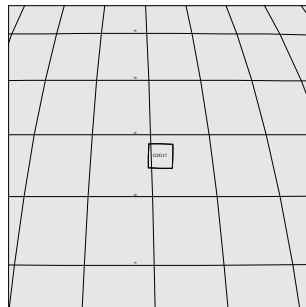

**G2GSDRKGRV01**  
GTE-CDS 22:14:0  
96-250/18:37:45

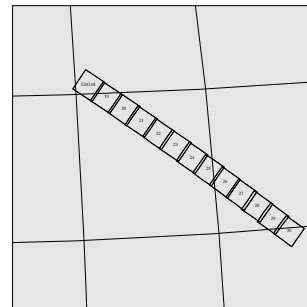

**G2GSPLMPST01**  
GTE-CDS 15:43:0  
96-250/18:44:30

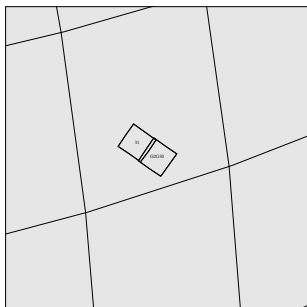

**G2GSURUKSL01**  
GTE-CDS 13:50:0  
96-250/18:46:27

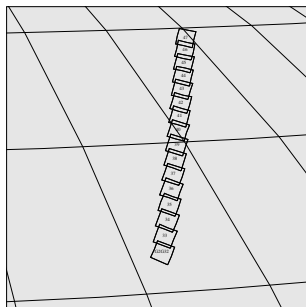

**G2GSLTDKBD01**  
GTE-CDS 9:00:0  
96-250/18:51:03

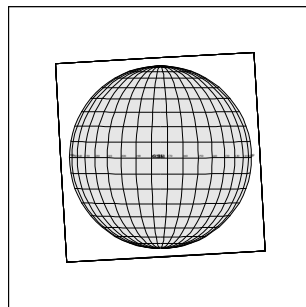

**G2ISSRFMON01**  
IEE-CDS 227:00:0  
96-251/01:35:29

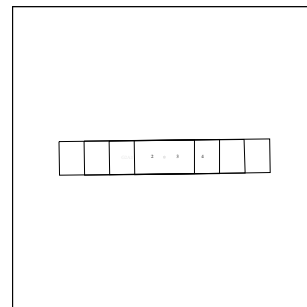

**G2SSAMALTH01**  
JEE-CDS 321:00:0  
96-251/08:12:51

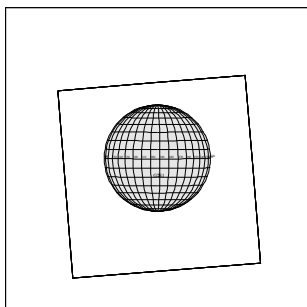

**G2ESPHOTOM01**  
EEE-CDS 146:00:0  
96-251/14:38:05

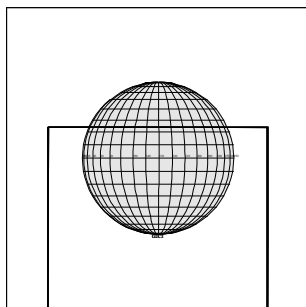

**G2CSPHOTOM01**  
CEE-CDS 1251:00:0  
96-252/13:19:03

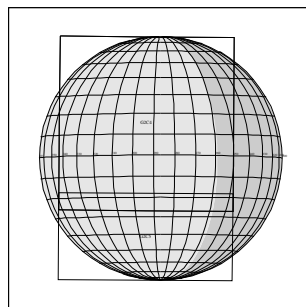

**G2CSVGRGAP01**  
CEE-CDS 3:00:0  
96-253/10:20:55

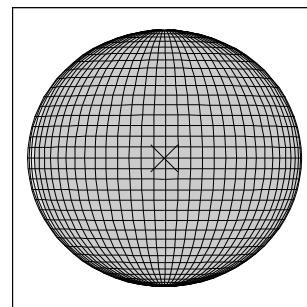

**G2NSHISCAL01**  
JEE+CDS 3037:00:0  
96-253/16:48:10

